



Press fittings for nebulisation systems



Contents

➤ 1.0 Nebulisation	2
➤ 2.0 Where is nebulisation used	2
➤ 3.0 Operating principle	3
➤ 3.1 Reduction of odours and dust	3
➤ 3.2 Cooling	3
➤ 4.0 Advantages	4
➤ 5.0 Components	4
➤ 5.1 Elements of the nebulisation system	5
➤ 5.2 Nozzles - Design and flow references	6
➤ 5.3 Technical characteristics of the components	7
➤ 6.0 Processing	8
➤ 6.1 Storage and transport	8
➤ 6.2 Pipes - cutting to length, deburring, bending	8
➤ 6.3 Marking the insertion depth	9
➤ 6.4 Press fitting seal ring check	9
➤ 6.5 Making the connection	9
➤ 7.0 Pressing tools	10
➤ 7.1 Basic indications	10
➤ 7.2 Approved pressing tools	10
➤ 7.3 Periodical equipment service	11
➤ 8.0 Approvals	11

1.0 Nebulisation

Nebulisation is the transformation of a liquid into small droplets, by passing the liquid through a very narrow orifice. Nebulisation should not be confused with humidification: during the nebulisation process, the liquid does not change state, albeit small the droplets still have macroscopic dimensions in the liquid phase, without passing into a vapour state [humidification].



Fig.1 - Nebulisation nozzle

2.0 Where is nebulisation used

Nebulisation is used in various construction fields from civil and industrial installations to the livestock and farming sectors.

Among the many uses, we briefly summarize here the typical contexts in which nebulisation is found.

Civil construction

Cooling environments during the summer in restaurants, hotels, nightclubs, spas, swimming pools, etc.



Fig.2 - Civil sector

Industrial construction

Reduction of odours and dust in workplaces such as wood and marble transformation industries as well as in construction, etc.

Cooling in harsh working environments (moulding industry, steel industry, ironing facilities, etc).



Fig.3 - Industrial sector

Animal husbandry and agriculture

Cooling of the animals, reduction of odours, humidification of greenhouses, spraying of chemicals, irrigation.



Fig.4 – Animal husbandry and agriculture sector

3.0 Operating principle

3.1 Reduction of odours and dust

The atomized water droplets, are attracted electrostatically with the particles present in the air and join together. By gravity, the tiny droplets that have captured the particles fall to the ground, purifying the air itself and also reducing electrostatic charges.

3.2 Cooling

Through special nozzles, the water is ejected under high pressure (up to 70 bar) turning into a fine mist. The nebulised water evaporates very quickly causing the cooling of the air in the warehouse/work environment and consequently lowers the temperature. This cooling effect saves energy because it reduces the operating times of fans. The table below shows a table indicative of the ambient temperature reduction in relation to the initial relative humidity.

Phase 1: dust is produced by the production process



Phase 2: dust is intercepted by nebulisation



Phase 3: the drops accumulate around the particles of dust which, become heavy and fall to the ground

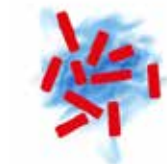

Maximum cooling capacity

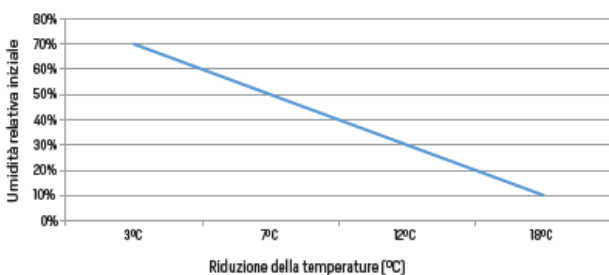

TABLE 1: MAXIMUM COOLING CAPACITY

Initial conditions	Temperature	36°C	36°C	36°C	36°C
	Humidity	10%	30%	50%	70%
Final conditions	Temperature	18°C	24°C	29°C	33°C
	Humidity	85%	85%	85%	85%
Cooling	°C	18°C	12°C	7°C	3°C

4.0 Advantages

The use of humidification in both civil and industrial environments leads to a series of important advantages, among which we summarize here:

- cooling improves the environment quickly without wetting the areas where applied;
- environmental humidity can be increased to the desired value: remember that the best level of relative humidity is between 60–70%;
- beneficial effect on the respiratory organs of both people (in the workplace) and animals (on farms);
- beneficial effect on the animals on farms in terms of maintaining the temperature and humidity conditions and the eviction of insects.

5.0 Components

In nebulisation systems pipes with small diameter (\varnothing 12–15 mm) are usually used.

The uses are varied and installation environments often critical in terms of resistance to corrosion, for this reason the most suitable material for this kind of application is stainless steel.

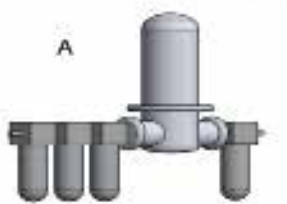
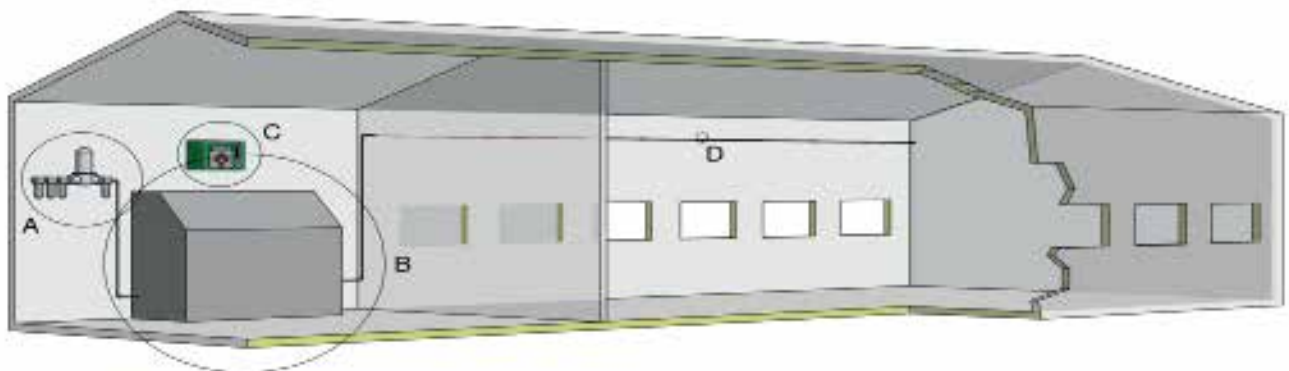

CENTRAL FILTERING UNIT

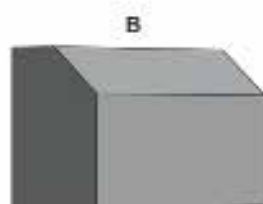

PUMP UNIT

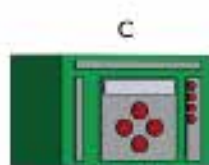

CONTROL PANEL



NOZZLE LINE

5.1 Elements of the nebulisation system

At the side is a summary of the components (pipes, fittings and accessories) in AISI 316L stainless steel, indispensable for the installation of a nebulisation system.

The fittings are supplied with a black sealing ring made of EPDM, suitable and certified for contact with drinking water.

Nebulisation occurs via the dedicated nozzles with calibrated orifices. The stainless steel AISI 316L nozzles together with the spray sleeve are shown in the figure below.



List of components for nebulisation

Pipe DN 15 x 1 mm thickness in AISI316L CODE: 116015200	Elbow DN 15 90° FF in AISI 316L CODE: 181015900
Elbow DN 15 90° FF in AISI 316L CODE: 181015901	Elbow DN 15 45° FF in AISI 316L CODE: 181015450
Elbow DN 15 45° MF in AISI 316L CODE:181015451	Sleeve DN 15 in AISI 316L CODE:183015000
Tee DN 15 in AISI 316L CODE:182015000	Cap DN 15 in AISI 316L CODE:183015003
Mixed male thread sleeve DN15x1/2" CODE:187102015	Mixed female thread sleeve DN15x1/2" CODE:190102015
Connection DN 15 for 1 nebuliser in AISI 316L CODE:195015017	Connection DN 15 for 2 nebulisers in AISI 316L CODE:195015027
Nebuliser connector 10/24" CODE: UPON REQUEST	Rubber-coated collars AISI 304 Dn15 CODE: 156150304G

5.2 Nozzles - Design and flow references

The number of nozzles to be installed in a system is defined according to the coverage requirements .

The following steps are recommended:

- 75 cm in the case of ventilated areas;
- 100 cm in the case of breeze;
- 125 cm in the case of still air (closed environments).

On average a nozzle covers a surface area of 1 m²

The distribution line is usually installed at a height of between 2 and 4 metres but given the flexibility of the nozzles, it is possible to go up to 6 metres high.

The diameter of the nebulised water droplet is defined as a function of the result that we want to obtain:

- 15 microns to obtain fast evaporation and no soaking (e.g. ambient cooling);
- 30/40 microns, for a heavier drop that is less subject to wind (e.g. removal of odours);
- 50 microns for a compact and wet fog (e.g. dust removal).

Below are the water flow rates of the nozzles as a function of the delivery pressure.

TABLE 2: NOZZLE FLOW IN LITRES PER MINUTE

Pressure	10 bar	20 bar	30 bar	40 bar	50 bar	60 bar	70 bar	80 bar	90 bar	100 bar	110 bar
15 µm	--	--	0.03	0.036	0.039	0.045	0.047	0.049	0.051	0.053	0.054
20 µm	--	0.042	0.051	0.054	0.064	0.07	0.072	0.076	0.08	0.083	0.085
30 µm	0.045	0.065	0.082	0.091	0.1	0.112	0.123	0.13	0.137	0.144	0.151
40 µm	0.065	0.089	0.11	0.126	0.136	0.155	0.164	0.173	0.182	0.191	0.2
50 µm	0.09	0.114	0.141	0.16	0.18	0.198	0.211	0.223	0.235	0.248	0.26
60 µm	0.115	0.137	0.165	0.195	0.22	0.25	0.267	0.285	0.307	0.32	0.332
80 µm	0.14	0.175	0.2	0.235	0.27	0.295	0.32	0.34	0.36	0.38	0.4
100 µm	0.165	0.195	0.228	0.265	0.305	0.332	0.36	0.38	0.405	0.43	0.447
120 µm	0.19	0.215	0.254	0.295	0.334	0.363	0.395	0.42	0.455	0.48	0.495

Calculation formulas

Minimum flow rate required by the pump = number of nozzles x characteristic flow of nozzle at the maximum working pressure. Maximum number of nozzles installed = pump flow rate / nozzle flow at max working pressure.

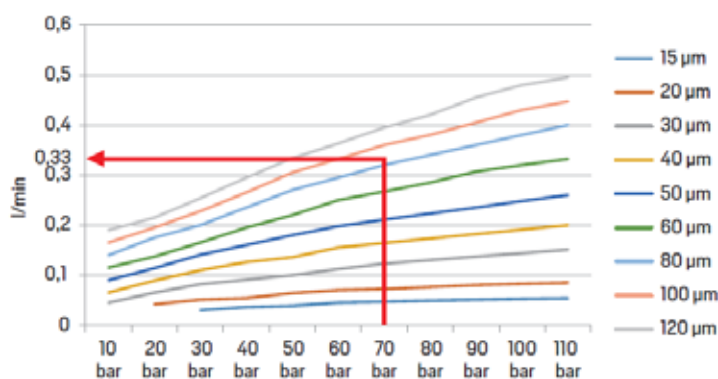

At 70 bar with an 80 µm nozzle, there is a flow of 0.33 l/min.

The press fittings DN 15 are tested at a maximum working pressure of 70 bar. Any other working condition, must be evaluated regularly. The designer has the responsibility to carry out detailed implementation planning and a risk analysis in accordance with the provisions of Directive 97/23/CE PED for pressurized systems.

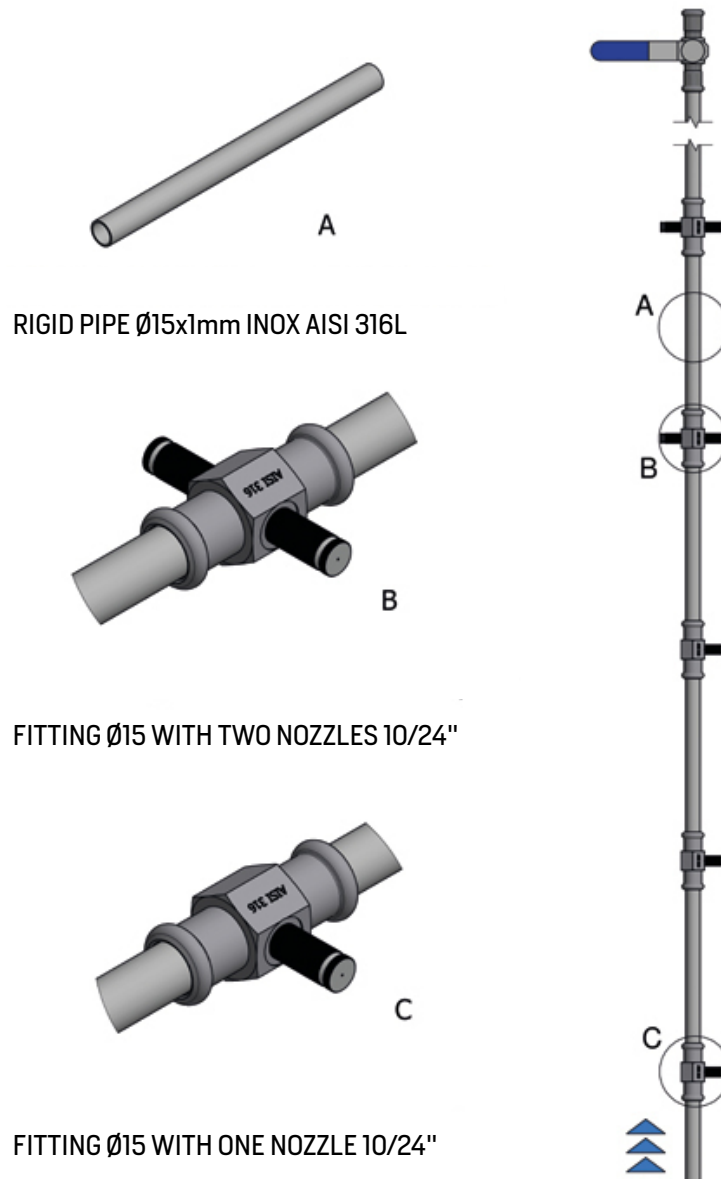

5.3 Technical characteristics of the components

► A

The components of the nebulisation systems have been tested to be used under the following working conditions:
Water with a maximum working pressure of 70 bar, having passed acceptance tests at the test pressure of 120 bars.

► B

Connectors for nebulisers have 10/24" threading in order to receive the corresponding nebulisers.

► C

The most commonly used nebulisers have a nebulisation nozzle diameter equal to 20/30 μm .

The nozzle has an anti-drip system and a removable deflector for the cleaning of the orifice measuring 0.02 / 0.03 mm.
For other required sizes consult Raccorderie Metalliche.

6.0 Processing

6.1 Storage and transport

inoxPRES system components have to be protected against dirt and damage during transport and storage.

The ends of the pipes are factory-fitted with plugs/caps to prevent dirt. The pipes must be stored in a cradle with a protective coating or protected with plastic material, so that they do not come in contact with other materials. Further more pipes and press fittings must be stored in an environment which is covered and protected from moisture exposure in order to prevent corrosion and / or oxidation of the surface.

6.2 Pipes - cutting to length, deburring, bending

The pipes should be cut to length using professional pipe cutters which are suitable for the material in use. Alternatively, fine-tooth hacksaws or suitable electric saws may be used.



Figure 5 - Cutting the pipe to length



Figure 6 - Deburring the pipe

Not permitted are:

- ❌ tools which cause over-heating of the material and tempering of colours during cutting;
- ❌ oil-cooled saws;
- ❌ flame cutting or cutting with angle grinders.

To avoid damaging the sealing ring when inserting the pipe into the press fitting, the pipe must be carefully debur-

red, both inside and outside, following cutting to required length.

This can be carried out using manual deburring tools which are suitable for the material in use, whilst for larger dimensions suitable electrical pipe deburring tools or files can be used. The \varnothing 15 mm pipes can be bent cold using standard bending tools ($R \geq 3.5 \times D$).

6.3 Marking the insertion depth

Sufficient mechanical strength of the press fitting connection will only be achieved if the insertion depths are adhered to as shown in table 3. These insertion depths are valid for pipes or fittings with insertion ends (i.e. fittings without pressfit end) and must be marked using a suitable marking tool.

**TABLE 3:
INSERTION DEPTH AND MINIMUM DISTANCES**

Pipe outside diameter mm	A [*] mm	D mm	L mm
15	20	20	60

*Tolerance: ± 2 mm

6.4 Press fitting seal ring check

Before assembly the sealing ring must be checked to ensure that it is lying in the pressing groove correctly and that it is clean and undamaged. If necessary, the sealing ring should be replaced.

Additionally, the fitter should check whether the ring in position is suitable for the special application, or whether it should be replaced with another sealing ring.

6.5 Making the connection

Using light pressure and making a turning movement at the same time, press the pipe into the press fitting up to the marked insertion depth. If the tolerances are so narrow that additional force is required to insert the pipe into the press fitting, then water or soapy water may be used as a lubricant.

Oil and grease are not permitted for use as lubricants.

Pressing is carried out using suitable electromechanical/ electrohydraulic pressing tools and dimension-matching pressing jaws or collars/chains. Tested and approved pressing tools or pressing jaws/collars/chains are listed under table 4-5.

The marking of the insertion depth on the pipe must be visible directly next to the press fitting groove following pressing. The distance of the marking on the pipe/fitting from the press fitting formed end may not exceed 10% of the required insertion depth, since otherwise the mechanical stability of the connection cannot be guaranteed.

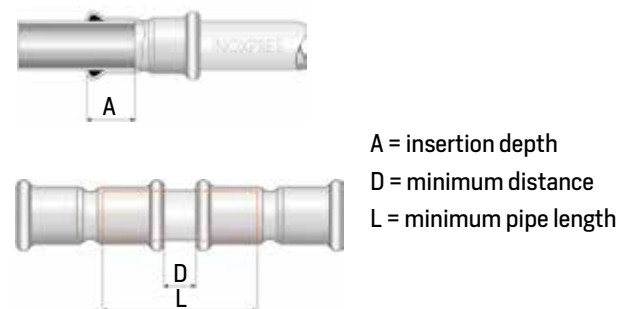

Figure 7 - Insertion depth and minimum dimensions



Figure 8 - Marking the insertion depth



Figure 9 - Checking the sealing ring

7.0 Pressing tools

7.1 Basic indications

Pressing tools basically consist of the pressing machine (= drive machine) and pressing jaws. Many of the pressing jaws/collars can generally be used with the pressing machines from one manufacturer. Additionally, many manufacturers of pressing tools have standardised the jaw attachment so pressing jaws from other manufacturers can also be used.

Principally, all metallic press fitting systems have a pressing contour on the press fittings which matches the profile of the pressing jaws/collars. For this reason it is necessary to have the approval of the tooling by the manufacturer of the press fittings intended for use. In addition, it is important to follow exactly the maintenance and servicing instructions issued by the pressing tool manufacturer.



Figure 10 – Klauke UAP3L



Figure 11 – Novopress AC0203

7.2 Approved pressing tools

RM approves the tools produced by Klauke and Novopress listed in the tables 4 and 5 below. These are pressing tools with the appropriate pressing jaws or collars/chains.

TABLE 4: MANUFACTURER KLAUKE

Type	Piston strength	Dimension range	Weight	Compatible with jaws from
MAP1 – MAP2L	15 KN	15 mm	~ 2.5 Kg	--
UAP2 – UAP3L	32 KN	15 mm	~ 3.5 Kg	Novopress EFP2 / EFP201 / AFP201 / EFP202 / AFP202 / ECO1 / AC01
UNP2	32 KN	15 mm	~ 3.5 Kg	Novopress EFP2 / EFP201 / AFP201 / EFP202 / AFP202 / ECO1 / AC01
UAP4 – UAP4L	32 KN	15 mm	~ 4.3 Kg	Novopress EFP2 / EFP201 / AFP201 / EFP202 / AFP202 / ECO1 / AC01
AH- P700LS	PKUAP3	32 KN	~ 12.3 Kg	Novopress EFP2/EFP201/AFP201 / EFP202/AFP202 / ECO1 / AC01
	PKUAP4	32 KN	~ 12.6 Kg	

TABLE 5: MANUFACTURER NOVOPRESS

Type	Piston strength	Dimension range	Weight	Compatible with jaws
ACO 102	19 KN	15 mm	~ 1.7 Kg	--
EFP2	32 KN	15 mm	~ 6.1 Kg	EFP 201 / AFP 201 / ECO 1 / ACO 1
EFP 201/EFP 202	32 KN	15 mm	~ 4.4 Kg	EFP 2 ECO 1 / ACO 1
AFP 201/AFP 202	32 KN	15 mm	~ 4.3 Kg	EFP 2 ECO 1 / ACO 1
ECO 202/ACO 202	32 KN	15 mm	~ 3.3 Kg	ECO 201 / ACO 201 ECO 1 / ACO 1
ACO 202XL ACO 203XL	32 KN	15 mm	~ 4.6 Kg	ECO 202 / ACO 202
ACO 3	36 KN	15 mm	~ 5.0 Kg	ECO 3
ECO 301	45 KN	15 mm	~ 5.0 Kg	ACO 3

7.3 Periodical equipment service

Jaw and chain pressing units are to be serviced to guarantee a correct joint. **The pressing tools must be checked by an officially authorized repairer according to the manufacturer specifications.**

Over and above any moving part (drive rolls) and pressing jaw and chain surfaces (internal profiles) are to be daily serviced, cleaned and lubricated.

As indicated also on UNI 7129-1 norm.

Any possible oxidation, paint or dirt in general affect the tool reliability leading to equipment sliding problems on joints during pressing.

8.0 Approvals

The following are the **inoxPRES** declaration of suitability for nebulisation. Any other documentation related to systems and materials must be requested from Raccorderie Metalliche.



DECLARATION OF SUITABILITY FOR NEBULISATION

(EN 10204 - 2.1_rev 0 of 11-2016)

relating to press fitting systems and stainless steel pipes

INOXPRES

RACCORDERIE METALLICHE S.p.A.

Strada Sabbionetana, 59
46010 Campitello di Marcaria
Mantova (ITALY)

DECLARES

that the INOXPRES press fitting systems and stainless steel pipes

- comply with the technical requirements envisaged for nebulisation systems for industrial, agricultural and outdoor use;
- are suitable for the construction of nebulisation networks with the following parameters;
 - > tube and fittings diameter 15mm (DN15)
 - > operating pressure 70 bar;
 - > operating pressure 120 bar;
 - > operating temperature range between -20 / +120 °C;
 - > fluid conveyed: water;
- comply with the requirements of the European Directive 97/23/EC (PED: Pressure Equipment Directive), article 3 paragraph 3;

The INOXPRES press fitting system and its components are manufactured under the quality management system certificate ISO 9001:2008.

Campitello di Marcaria, November 2016

Ceccardi Guido

Chief Executive Officer (CEO)

**RACCORDERIE
METALLICHE S.p.A.**
Sede e Stabilimento:
Strada Sabbionetana, 59 - 46010
Campitello di Marcaria (MN) Italy

Tel. +39 0376 96001
Fax +39 0376 96422
info@racmet.com

Cap. soc. € 3.039.000 I.v.
Registro Imprese MN 02066990173
Codice Fiscale 02066990173

Partita IVA 01591820202
R.E.A. 169204

raccorderiemetalliche.com



DECLARATION OF SUITABILITY FOR NEBULISATION

(EN 10204 - 2.1_rev 0 of 11-2016)

relating to press fitting systems and stainless steel pipes

INOXPRES

CORRECT USE OF THE SYSTEM

For correct use of the INOXPRES press fitting system, and successful installation please refer to the following documents:

- > Press fitting Technical Manual of Raccorderie Metalliche;
(on the website www.racmet.com the latest updated edition is always available)
- > National regulations in force in the field of design, installation and maintenance of nebulisation systems;

The INOXPRES press fitting system is used in nebulisation systems used for:

- > cooling, disinfection, dust suppression in agriculture (farms);
- > landscaping, cooling, disinfestation in outdoor areas (gardens, exterior environments);
- > Micro-irrigation of green walls;
- > Cooling, humidification, dust suppression in the industrial sector (textiles, wineries, etc.).

For the delivery of water containing specific chemicals in the system it is necessary to check the compatibility of these substances with the stainless-steel pipes and fittings and the seal inserted in each fitting.

For the selection of pressing equipment, please refer to the Press fitting Technical Manual and use equipment declared compatible and suitable for use by Raccorderie Metalliche S.p.A.

Where required, the designer or installer must apply for the technical opinion of recognized body, which can approve the plant and choice of components installed.

Raccorderie Metalliche S.p.A. leaves it to the plant designer to assess the conformity of the INOXPRES press fitting system in accordance with territorial regulations and national laws that specify and regulate the design, installation and maintenance of systems.

**RACCORDERIE
METALLICHE S.P.A.**
Sede e Stabilimento:
Strada Sabbionetana, 59 - 46010
Campitello di Marcara (MN) Italy

Tel. +39 0376 96001
Fax +39 0376 96422
info@racmet.com

Cap. soc. € 3.039.000 I.v.
Registro Imprese MN 02066990173 Partita IVA 01591820202
Codice Fiscale 02066990173 R.E.A. 169204

raccorderiemetalliche.com



DECLARATION OF SUITABILITY FOR NEBULISATION

(EN 10204 - 2.1_rev 0 of 11-2016)

relating to press fitting systems and stainless steel pipes

INOXPRES

INOXPRES PRESS FITTING SYSTEM CHARACTERISTICS

Taking note of the following regulations:

- > Art. 7 – Ministerial Decree 37 of 22-01-08 – Rules for plant safety;
- > Art. 5 – Law No. 447 of 06/12/91 – Regulation implementing Law No. 46/90;

CERTIFIES

- > that the INOXPRES system consists of press fittings, o-rings in EPDM (-20 +120°C), connecting pipes, pressing tools and suitable clamps or chains;
- > that the INOXPRES system is approved by the leading international certification bodies such as: DVGW – Germany, CSTBat - France, ETA - Denmark, WRAS – UK, VdS – Germany;
- > that the material used for the production of INOXPRES press fittings is AISI 316, 1.4404, in compliance with EN 10088 – EN 10312 – EN 10217-7;
- > that INOXPRES press fittings are manufactured according to UNI 11179 and the technical regulations of the leading international certification bodies;
- > that INOXPRES pipes are made of stainless steel AISI 316L – 1.4404, AISI 304L – 1.4307, TYPE 444 - 1.4521, in compliance with EN 10088 – EN 10312 – EN 10217-7;
- > that all the threads for the INOXPRES system are produced according to EN 10226-1 (DIN 2999 – UNI ISO 7/1) or UNI ISO 228/1 (DIN 259);
- > that all the welds on the fittings for the INOXPRES system are 100% controlled, under pressure with automatic machines;
- > that the chloride content contained in the conveyed water, does not exceed 250 mg/l;

**RACCORDERIE
METALLICHE S.P.A.**
Sede e Stabilimento:
Strada Sabbionetana, 59 - 46010
Campitello di Marcaria (MN) Italy

Tel. +39 0376 96001
Fax +39 0376 96422
info@racmet.com

Cap. soc. € 3.039.000 I.v.
Registro Imprese MN 02066990173
Codice Fiscale 02066990173

Partita IVA 01591820202
R.E.A. 169204

raccorderiemetalliche.com



- > that the seals used by the INOXPRES system are made of EPDM and approved according to:
DIN 681 – 1 Typ WB; KTW 1.3.13 elastomers sector D2; WBS Water Byelaws Scheme - BS 6920; ANSI / NSF Standard 61; FDA - title 21 - part 170 – 199 – item 177.2600 (e) + (f).
Supplement: compression strength test, DVR, 3000 hours / 110°C;
- > that the INOXPRES system components are not subject to CE marking as prescribed by Legislative Decree no. 93 of 25 February, 2000;

Campitello di Marcaria, November 2016

Ceccardi Guido

Chief Executive Officer (CEO)

Pozzetti Silvio

Head of Quality System

Pizzamiglio Fabrizio

Product Manager Plumbing & Heating Division

**RACCORDERIE
METALLICHE S.P.A.**
Sede e Stabilimento:
Strada Sabbionetana, 59 - 46010
Campitello di Marcaria (MN) Italy

Tel. +39 0376 96001
Fax +39 0376 96422
info@racmet.com

Cap. soc. € 3.039.000 I.v.
Registro Imprese MN 02066990173
Codice Fiscale 02066990173

Partita IVA 01591820202
R.E.A. 169204

raccorderiemetalliche.com



Raccorderie Metalliche S.p.A.

Head Office and Manufacturing Plant:

Strada Sabbionetana, 59

46010 Campitello di Marcaria (MN) ITALY

Tel. +39 0376 96001

Fax +39 0376 96422

info@racmet.com

raccorderiemetalliche.com

CODE103 RO 0317 GBR